



Roadranger®

More time on the road®

Illustrated Parts List

FS-6406A
July 2011

Contents

How To Use The Illustrated Parts List	3
CASE.....	4
COUNTERSHAFT ASSY	7
INPUT SHAFT.....	8
KITS & ASSEMBLIES	9
LEVER ASSY	10
MAINSHAFT ASSY.....	12
MISCELLANEOUS	14
REMOTE CONTROL.....	15
REVERSE IDLER GEAR ASSY	17
SHIFT BAR HOUSING	18

How To Use The Illustrated Parts List

The information contained in this document is subject to frequent updates. Therefore, for the latest information available, please visit the interactive Electronic Parts Catalog at www.roadranger.com/epc.

Model Designation or Nomenclature

- For information regarding Model Designation and Nomenclature, visit www.roadranger.com.

Kits and Assemblies (K/A's)

- Kits and Assemblies contain groups of individual or assembled parts developed for optimal replacement or repair of a service problem.
- Kits and Assemblies are shown with applicable parts groupings in the parts listings.

Identifying Kits and Assemblies

A- Part numbers beginning with the letter 'A' are pre-assembled Production Assemblies

K- Part numbers beginning with the letter 'K' are kits that are not assembled

S- Part numbers beginning with the letter 'S' are pre-assembled Service Assemblies

- Note: Some Production Assemblies do not begin with a letter prefix (Midrange only).

Illustrations

- Illustrations show parts in assembly groups.
- Item numbers on illustrations correspond with parts listings on pages adjacent to the illustration.
- Notes are included on illustrations where additional information is needed.

Parts Listing

Parts listings are defined by parts groupings and are broken down by service assemblies. Parts listings identify a part for servicing with the following categories

- **Item Number** - corresponding with numbers on illustrations for part identification.
- **Current Part** - identifies part as it is available for service.
- **Description** - specifies part name or description.
- **Replaced Part** - quantity quantity required for assembly.
- **Quantity** - defines unique characteristics or requirements.
- **Notes** - indicates Kits or Assemblies that contain a particular part.
- **Kits/Assy's Where Used**

Rear Bearing Cover Options

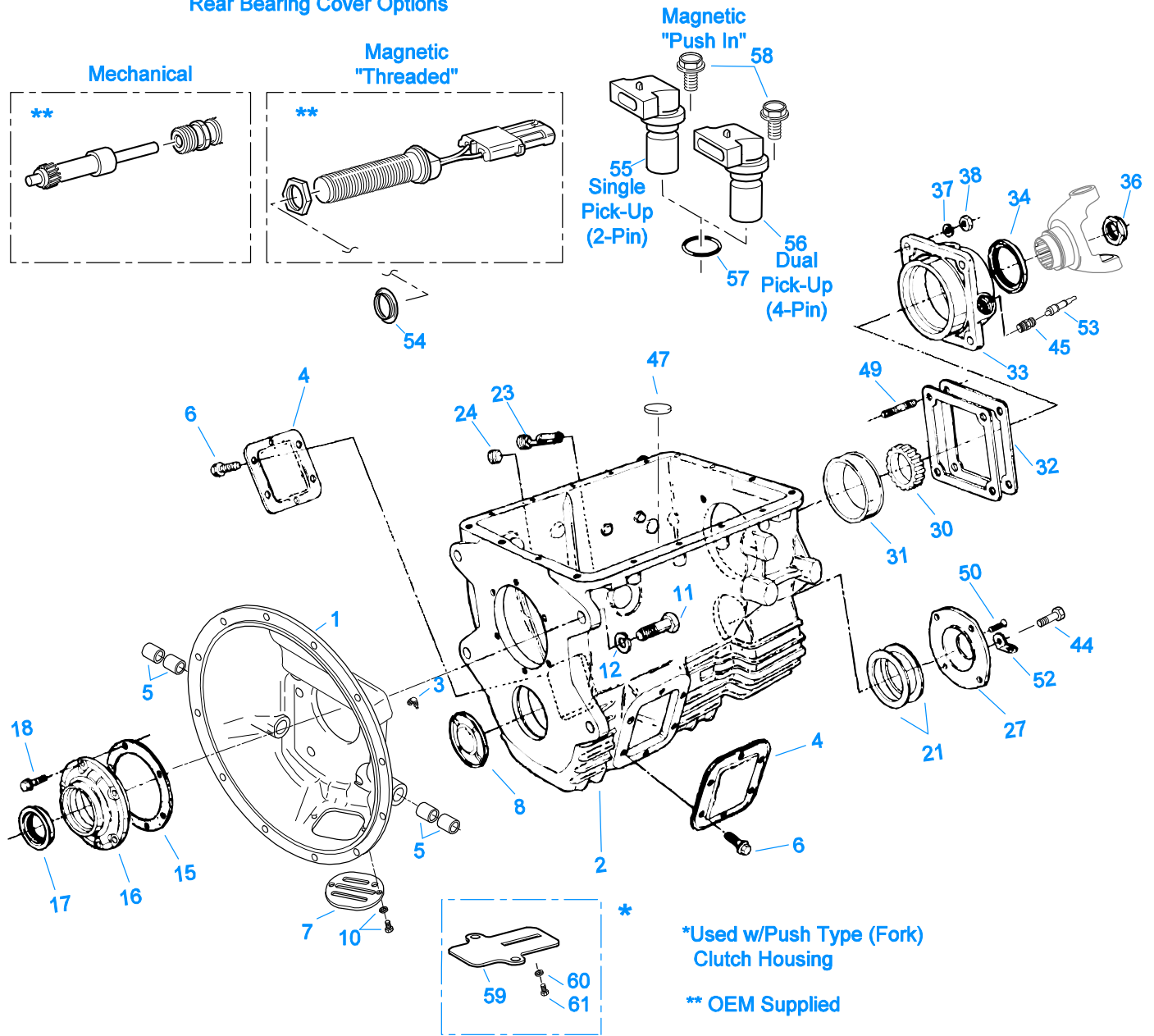

00184-8-99

CASE

Item	Current Part	Description	Replaced Part	Qty.	Notes	Kits/Assys Where Needed
1	A-5205	CLUTCH HSG ASSY	21646	1	#2 ALUMINUM, BELOW CENTER LINE PUSH TYPE	
1	A-5631	CLUTCH HSG ASSY	23723	1	#2 PULL-IRON, W/90 DEG FITTINGS	
1	A-5634	CLUTCH HSG ASSY	23726 ,3316236 ,3316237 ,A - 5632 ,A - 5771	1	#2 ALUMINUM, ABOVE CENTER LINE PULL TYPE	
1	A-5751	CLUTCH HSG ASSY	4300418	1	#2 ALUMINUM, BELOW CENTER LINE PUSH TYPE	
1	A-5878	CLUTCH HSG ASSY	4300744	1	#2 PULL-ALUMINUM	
1	A-6228	CLUTCH HSG ASSY	23723	1	#2 PULL-IRON, W/45 DEG FITTINGS	
1	A-7514	CLUTCH HSG ASSY	3316241	1	#2 ALUMINUM, PUSH TYPE (FORK)	
2	S-2952	CASE ASSY	3316276 ,4301285 ,4304643 ,4305177	1		
3	4300301	FITTING-45 DEGREE	11H15	2		
3	4872	FITTING-90 DEGREE	12H15	2		

Item	Current Part	Description	Replaced Part	Qty.	Notes	Kits/Assys Where Needed
4	201398	PTO COVER		2		
5	12815	BUSHING		4		A-5631,A-5634,A-5751,A-5878,A-6228
5	8677	BUSHING		2	USE W/A-5205 CLUTCH HSG ASSY	A-5205
6	239613	CAPSCREW		12	3/8"-16X5/8"	
7	23380	COVER	206466	1		A-5205,A-5631,A-5634,A-5751,A-5878,A-7514
8	3315679	PLUG		1		K-3423
10	X-8L-408	SCREW & WASHER ASSY		2		
11	X-8-1011	CAPSCREW	1C1036	4	5/8"-11X2-1/4"	
12	X-3-1000	LOCKWASHER		4	5/8"	
15	3315659	GASKET		1		K-7028
16	21893	FRONT BRG COVER-PUSH		1	USE 4300798 OIL SEAL	
16	21982	FRONT BRG COVER-PUSH		1	USE 4300798 OIL SEAL	
16	3316313	FRONT BRG COVER-PUSH		1	USE 4300798 OIL SEAL	
16	4300650	FRONT BRG COVER-PUSH		1	USE 4300204 OIL SEAL	
16	4300887	FRONT BRG COVER-PUSH		1	USE 4300204 OIL SEAL	
16	4300888	FRONT BRG COVER-PULL		1	USE 4300121 OR 4300204 OIL SEAL	
16	4301144	FRONT BRG COVER-PULL		1	USE 4300121 OIL SEAL	
16	4302356	FRONT BRG COVER-PULL		1	USE 4300121 OR 4300204 OIL SEAL	
17	4300121	OIL SEAL	3315623	1	SHAFT 1.873, WIDTH .375, OD 2.68	K-3423
17	4300204	OIL SEAL	235394	1	SHAFT 1.873, WIDTH .375	
17	4300798	OIL SEAL	235393	1	SHAFT 1.625, WIDTH .375	
18	239614	SCREW		6	5/16-18X.81	
21	3315681	SHIM .004		1	QUANTITY AS REQUIRED	K-2183
21	3315682	SHIM .007		1	QUANTITY AS REQUIRED	K-2183
21	3315683	SHIM .010		1	QUANTITY AS REQUIRED	K-2183
21	3315684	SHIM .020		1	QUANTITY AS REQUIRED	K-2183
21	4300977	SHIM .040		1		
23	X-12-1207	PIPE PLUG	X12 1202 X12 1206	1	3/4" MAGNETIC	
24	X-12-1210	PIPE PLUG	X12 1206	1		
27	4301607	C/S REAR BRG COVER		1		
30	3316160	SPEEDO ROTOR		1	16 TEETH	
30	3316283	SPEEDO DRIVE GEAR		1	6 TEETH	
30	4300003	SPEEDO ROTOR		1	6 TEETH	
30	86302	SPEEDO DRIVE GEAR		1	5 TEETH	
30	86310	NO LONGER AVAILABLE		1	6 TEETH	
31	711123	BEARING CUP		1		K-3423
32	3315662	SHIM .004		1	QUANTITY AS REQUIRED	K-2183
32	3315663	SHIM .007		1	QUANTITY AS REQUIRED	K-2183
32	3315664	SHIM .010		1	QUANTITY AS REQUIRED	K-2183
32	3315665	SHIM .020		1	QUANTITY AS REQUIRED	K-2183
32	4300978	SHIM .040		1		
33	21901	NO LONGER AVAILABLE		1	USE 4300119 OIL SEAL	
33	21947	REAR BRG COVER		1	USE 4300119 OIL SEAL	
33	22020	REAR BRG COVER		1	USE 4300119 OIL SEAL	
33	3316278	REAR BRG COVER		1	USE 4300119 OIL SEAL	
33	K-7044	REAR BRG COVER KIT	4302620	1	USE 4300119 OIL SEAL NOTE: PUSH-IN TYPE SPEEDO SENSOR	
33	K-7045	REAR BRG COVER KIT	4302621	1	USE 4300119 OIL SEAL NOTE: PUSH-IN TYPE SPEEDO SENSOR	
33	S-7035	REAR BRG COVER ASSY	23248 ,4301987	1	USE 4300119 OIL SEAL NOTE: SENSOR SEAL REQUIRED	
33	S-7036	REAR BRG COVER ASSY	21979 ,4302005	1	USE 4300119 OIL SEAL NOTE: SENSOR SEAL REQUIRED	
33	S-7037	REAR BRG COVER ASSY	3315657 ,4302029	1	USE 4300119 OIL SEAL NOTE: SENSOR SEAL REQUIRED	
33	S-7038	REAR BRG COVER ASSY	4300746 ,4302100	1	USE 4300119 OIL SEAL NOTE: SENSOR SEAL REQUIRED	
34	4300119	OIL SEAL		1	SHAFT 2.753, WIDTH .5	K-3423
36	K-3411	NUT KIT	21937 ,4301920 ,4304690	1		
37	239436	WASHER		4	1/2"	
38	86D8	NUT	86D08	4	1/2"-20	
44	X-8C-604	CAPSCREW		4	3/8"-16X1-1/4"	
45	3316225	SLEEVE		1		
45	86147	SLEEVE		1		
47	14373	MAGNET		1		S-2952
49	239433	STUD		4	1/2"-20X2-5/16"	
50	X-12-405	PIPE PLUG		1		
52	238370	LIFTING EYE		1		
53	86303	SPEEDO DRIVEN GEAR		1	15 TEETH	

Item	Current Part	Description	Replaced Part	Qty.	Notes	Kits/Assys Where Needed
53	86304	NO LONGER AVAILABLE		1	15 TEETH	
53	86309	NO LONGER AVAILABLE		1	12 TEETH	
53	86316	NO LONGER AVAILABLE		1	13 TEETH	
54	4301954	SENSOR SEAL		1		S-7035,S-7036,S-7037,S-7038
55	K-3454	SPEED SENSOR KIT	A - 6398 ,A - 6724	1	SINGLE PICK-UP (2 PIN)	
56	K-3455	SPEED SENSOR KIT, DUAL	A - 7046 ,A - 7518	1	DUAL PICK-UP (4 PIN)	
57	14142	-O- RING		1		K-7044,K-7045
58	X-8C-409	CAPSCREW		1	1/4"-20X5/8" RETAINER FOR SENSORS	
59	23639	COVER		1	USED ON LEFT OR RIGHT SIDE	
60	X-3-400	LOCKWASHER	4E04	2	1/4"	
61	1C408	CAPSCREW		2	1/4"-20	

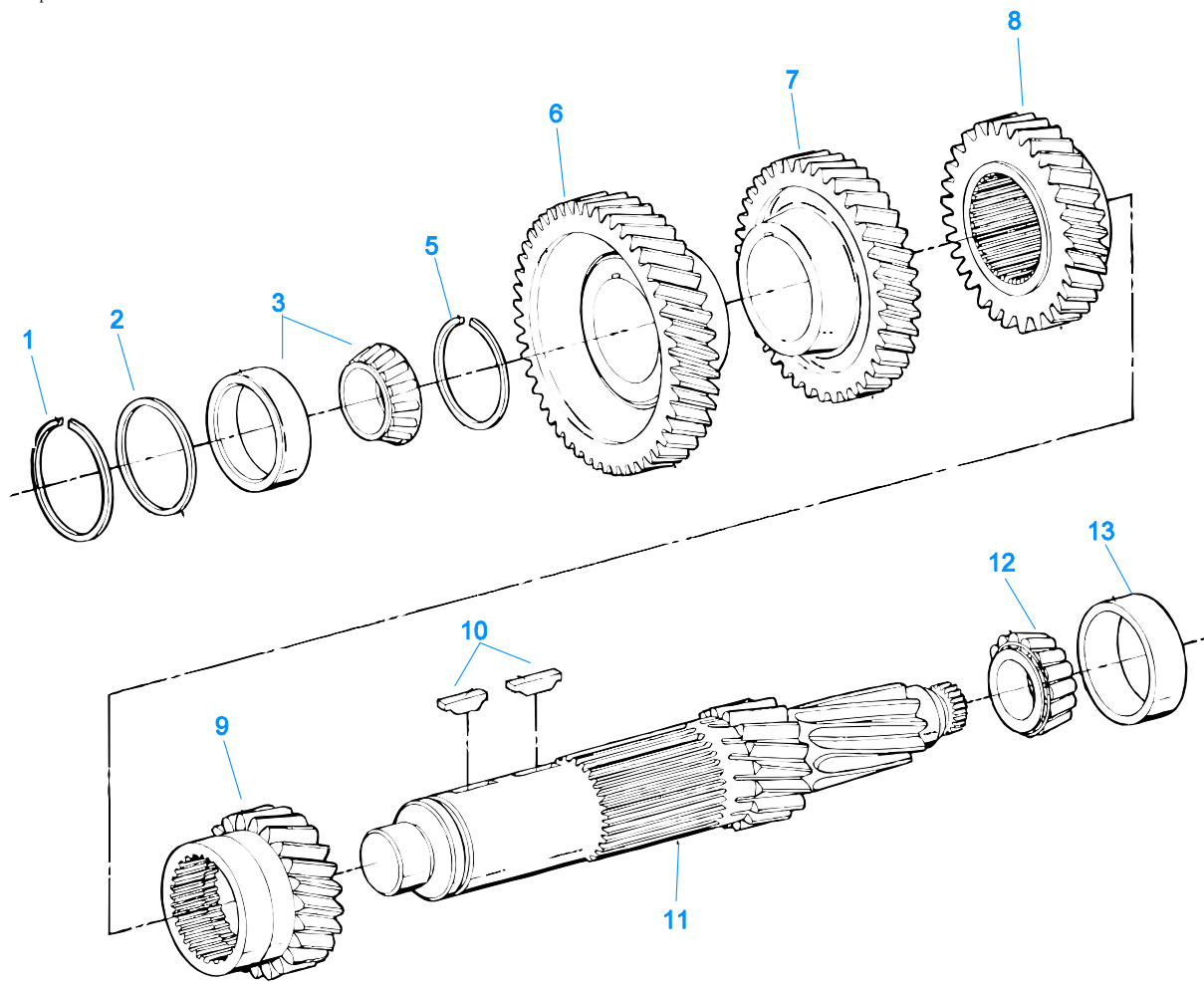

00303-8/93 CS 53

COUNTERSHAFT ASSY

Item	Current Part	Description	Replaced Part	Qty.	Notes	Kits/Assys Where Needed
1	3315686	SNAP RING		1		
2	3315687	WASHER		1		K-3422,K-3423
3	K-3795	COUNTERSHAFT BRG KIT	1313645, 791943	1		K-3422
5	3315752	SNAP RING	3315751	1		
6	3315743	DRIVE GEAR-CNTRSHFT		1		
7	4301478	5TH GEAR-CNTRSHFT		1		
8	4304097	4TH GEAR-CNTRSHFT	4304099	1		
9	4304056	3RD GEAR-CNTRSHFT	4304062	1		
10	230292	KEY		2		K-3422
11	4303238	COUNTERSHAFT	3315740	1		
12	658981	BEARING CONE		1		K-3423
13	660181	BEARING CUP		1		K-3423

Group: INPUT SHAFT

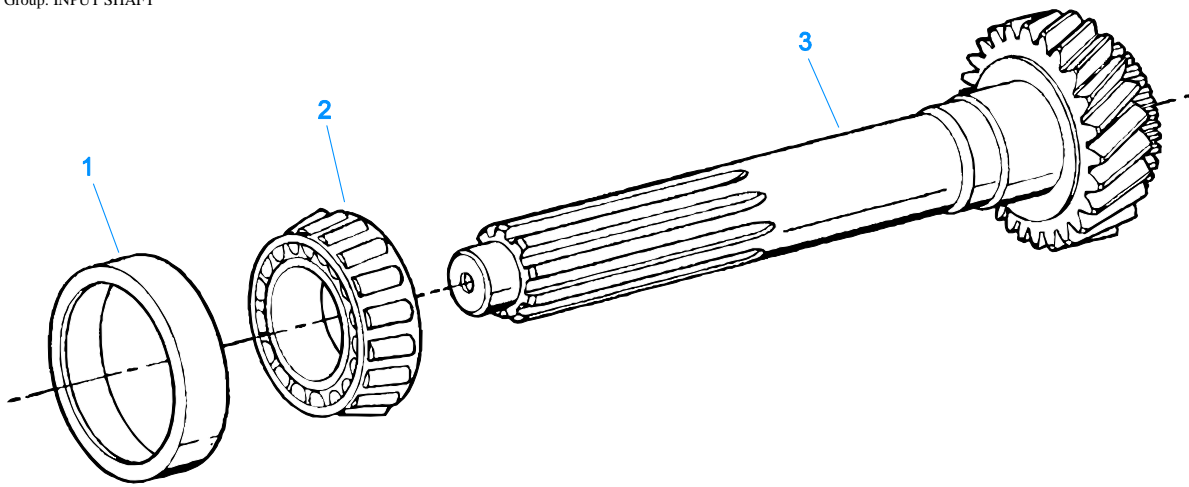

00401-8/93 IS 62

INPUT SHAFT

Item	Current Part	Description	Replaced Part	Qty.	Notes	Kits/Assys Where Needed
1	675250	BEARING CUP		1	1.75" INPUT	K-3423
1	711123	BEARING CUP		1	1.50" INPUT	K-3423
2	5557003	BEARING CONE	5202047	1	1.50" INPUT	K-3423
2	742259	BEARING CONE		1	1.75" INPUT	K-3423
3	4301402	INPUT SHAFT-1.50" PULL		1	USE 21893 FRONT BRG COVER	
3	4301403	INPUT SHAFT-1.75" PULL		1	USE 3316171, 4300888 OR 4301144 FRONT BRG COVER	
3	4301404	INPUT SHAFT-1.50		1	USE 21982 FRONT BRG COVER	
3	4301408	INPUT SHAFT-1.50" PUSH		1	USE 3316313 FRONT BRG COVER	
3	4301409	INPUT SHAFT-1.50" PULL		1	USE 4300650 FRONT BRG COVER	
3	4301485	INPUT SHAFT-1.75" PULL		1	USE 3316171 OR 4301144 FRONT BRG COVER	

KITS & ASSEMBLIES

Item	Current Part	Description	Replaced Part	Qty.	Notes	Kits/Assys Where Needed
K-2183		SHIM KIT		1		
K-3411		NUT KIT	21937 ,4301920 ,4304690	1		K-3423
K-3421		SYNCHRONIZER KIT	K - 7004	1		
K-3422		SMALL PARTS KIT		1		
K-3423		BASIC REBUILD KIT		1		
K-3795		COUNTERSHAFT BRG KIT	1313645, 791943	1		
K-7028		GASKET KIT		1		K-3423
K-7044		REAR BRG COVER KIT	4302620	1		
K-7045		REAR BRG COVER KIT	4302621	1		
K-7051		SYNCHRONIZER KIT -3/4		1		
K-7061		SHIFT LEVER HSG KIT	241075 ,4302711 ,A - 6439	1	ALUMINUM HOUSING MEDIUM - LEVER HEIGHT 3-1/8"	
K-7062		SHIFT LEVER HSG KIT	233080 ,4302711 ,A - 6440	1	ALUMINUM HOUSING HIGH - LEVER HEIGHT 3-1/2"	
K-7065		SHIFT LEVER HSG KIT	4302704 ,4302711 ,A - 6448	1	ALUMINUM HOUSING LOW - LEVER HEIGHT 2-7/8"	
K-7069		REMOTE CONTROL KIT	A - 5403	1	LEVER HEIGHT 85MM (3.35")	
S-1578		SHIFT LEVER ASSY 3-1/2"		1	COMPLETE ASSY - ALUMINUM HOUSING HIGH - LEVER HEIGHT 3- 1/2" 27-1/2" STRAIGHT LEVER - "BEND TO SUIT" 3/8" X 24 THREAD	
S-1827		SHIFT LEVER ASSY 3-1/8"	S-7079	1	COMPLETE ASSY - ALUMINUM HOUSING MEDIUM - LEVER HEIGHT 3-1/8" 27-1/2" STRAIGHT LEVER - "BEND TO SUIT" 3/8" X 24 THREAD	
S-2861		SHIFT BAR HSG ASSY	4303606	1	COMPLETE REVERSE SWITCH POSITION - RIGHT FRONT	
S-2952		CASE ASSY	3316276 ,4301285 ,4304643 ,4305177	1		
S-7035		REAR BRG COVER ASSY	23248 ,4301987	1		
S-7036		REAR BRG COVER ASSY	21979 ,4302005	1		
S-7037		REAR BRG COVER ASSY	3315657 ,4302029	1		
S-7038		REAR BRG COVER ASSY	4300746 ,4302100	1		
S-7045		SHIFT LEVER ASSY 2-7/8"		1	COMPLETE ASSY - ALUMINUM HOUSING LOW - LEVER HEIGHT 2- 7/8" 33" STRAIGHT LEVER - "BEND TO SUIT" 3/8" X 24 THREAD	

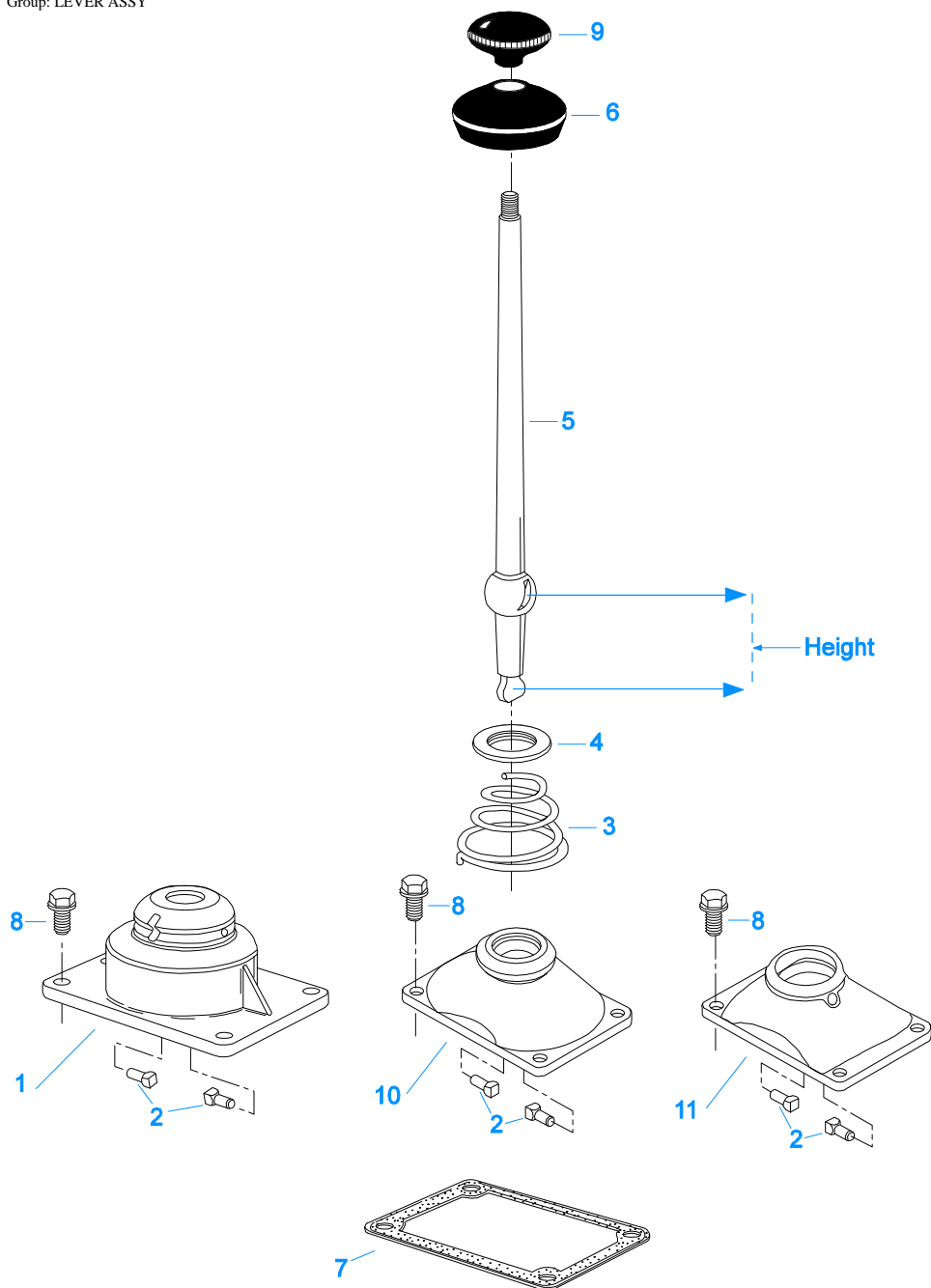

00171-3-94 LA

LEVER ASSY

Item	Current Part	Description	Replaced Part	Qty.	Notes	Kits/Assys Where Needed
1	K-7062	SHIFT LEVER HSG KIT	233080 ,4302711 ,A - 6440	1	ALUMINUM HOUSING HIGH - LEVER HEIGHT 3-1/2"	
2	201054	PIN		2	FOR HSGS WITHOUT PIN SLEEVES	
2	23180	PIN		2	FOR HSGS WITH PIN SLEEVES	K-7061,K-7062,K-7065,S-1578,S-1827,S-7045
3	4300690	SPRING	229337	1		S-1578,S-1827,S-7045
4	23181	WASHER		1		S-1578,S-1827,S-7045
5	21722	SHIFT LEVER 27-1/2"		1	USE WITH K-7062 STRAIGHT LEVER - "BEND TO SUIT"	S-1578
5	228648	GEAR SHIFT LEVER		1	USE WITH 233080 STRAIGHT LEVER - "BEND TO SUIT"	

Item	Current Part	Description	Replaced Part	Qty.	Notes	Kits/Assys Where Needed
5	241076	SHIFT LEVER 27-1/2"		1	USE WITH K-7061 STRAIGHT LEVER - "BEND TO SUIT"	S-1827
5	4302823	SHIFT LEVER 33"		1	USE WITH A-6448 STRAIGHT LEVER - "BEND TO SUIT"	S-7045
6	202484	DUST COVER		1		S-1578,S-1827,S-7045
7	4301958	GASKET		1		K-7028,K-7061,K-7062,K-7065,K-7069,S-1578,S-1827,S-7045
8	X-8C-604	CAPSCREW		4	3/8"-16X1-1/4"	
9	201401	SHIFT KNOB		1	3/8"X24 THREAD	S-1578,S-7045
10	K-7061	SHIFT LEVER HSG KIT	241075 ,4302711 ,A - 6439	1	ALUMINUM HOUSING MEDIUM - LEVER HEIGHT 3-1/8"	
11	K-7065	SHIFT LEVER HSG KIT	4302704 ,4302711 ,A - 6448	1	ALUMINUM HOUSING LOW - LEVER HEIGHT 2-7/8"	

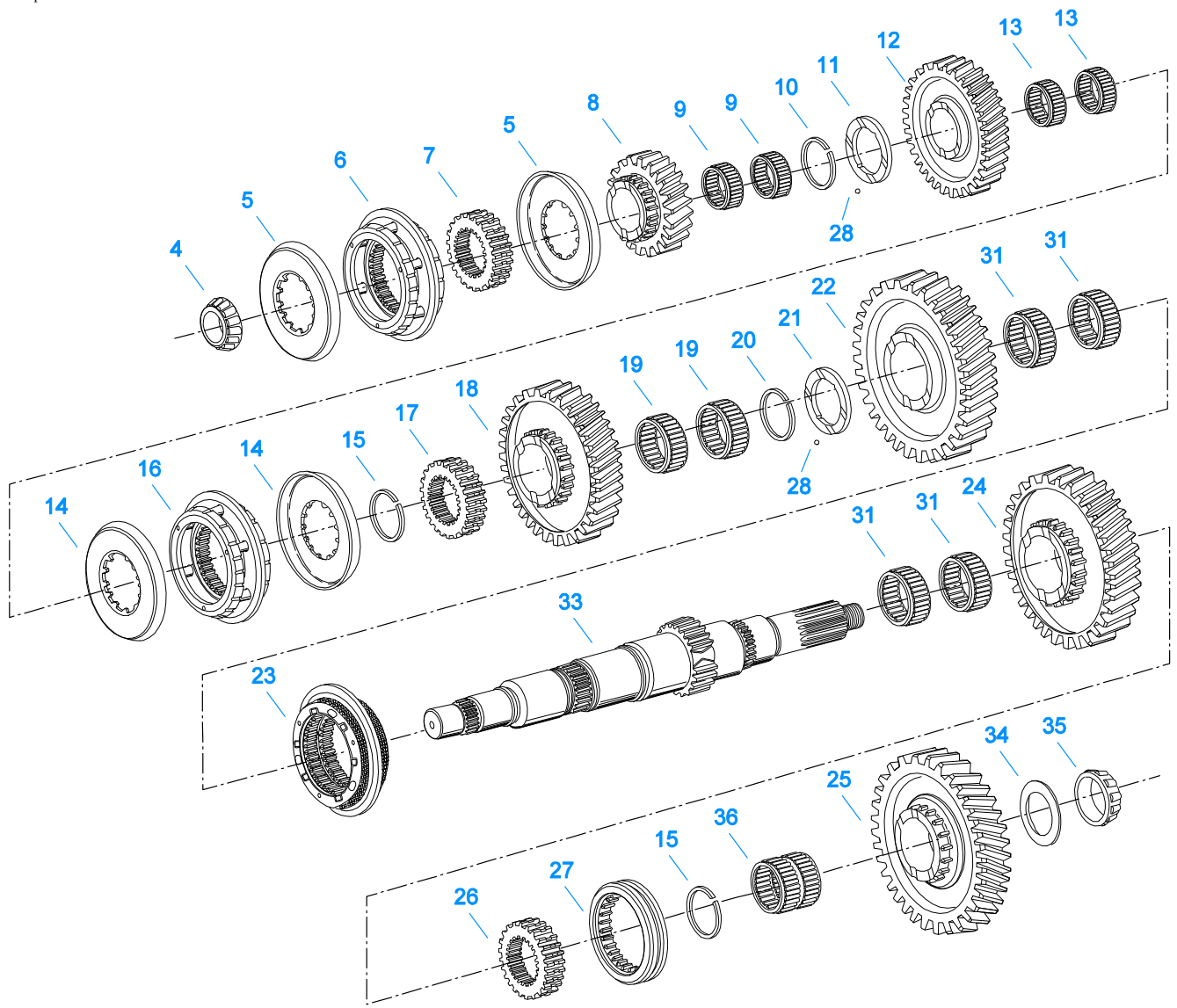

00207-8-99 MS 64

MAINSHAFT ASSY

Item	Current Part	Description	Replaced Part	Qty.	Notes	Kits/Assys Where Needed
4	710787	BEARING CONE		1		K-3423
5	4301467	SYNCHRONIZER CUP 5/6		2		K-3421
6	A-6608	SYNCHRONIZER ASSY 5/6	A - 6137	1		K-3421
7	4301476	CLUTCH HUB 5/6		1		
8	4301477	5TH GEAR-MAINSHAFT		1		
9	3315737	BEARING		2		K-3423
10	3315728	SNAP RING	3315729	1		K-3422
11	3315727	WASHER		1		K-3422
12	4304098	4TH GEAR-MAINSHAFT	4304401	1		
13	4124075	BEARING		2		K-3423
14	4301466	SYNCHRONIZER CUP 3/4		2		K-7051
15	3315725	SNAP RING		2		K-3422,K-3423
16	A-6136	SYNCHRONIZER ASSY 3/4	4301457 4304050 ,4304452	1		K-7051
17	4301475	CLUTCH HUB 3/4		1		
18	4304057	3RD GEAR-MAINSHAFT	4304063	1		
19	3315722	BEARING		2		K-3423

Item	Current Part	Description	Replaced Part	Qty.	Notes	Kits/Assys Where Needed
20	3315717	SNAP RING	3315718	1		K-3422
21	3315719	WASHER		1		K-3422
22	4304544	2ND GEAR-MAINSHAFT	4303811 ,4303945	1		
23	A-7934	SYNCHRONIZER ASSY 1/2	4304551 ,A - 6801,A-6932	1		
24	4304545	1ST GEAR-MAINSHAFT	4303809 ,4303946	1		
25	4304547	REVERSE GEAR-MAINSHAFT		1		
26	4301474	CLUTCH HUB-REV		1		
27	4304550	SLIDING CLUTCH-REV		1		
28	10J06	STEEL BALL		2	3/16"	K-3422
31	3315703	BEARING		4		K-3423
33	4304549	MAINSHAFT	4303808	1		
34	4301492	WASHER		1		K-3422
35	5557003	BEARING CONE		1		K-3423
36	4304555	BEARING		1		K-3423

MISCELLANEOUS

Item	Current Part	Description	Replaced Part	Qty.	Notes	Kits/Assys Where Needed
71203		SILICONE LUBE		1	8 OZ (236.59 CC)-FLEET SIZE	
71204		ADHESIVE SEALANT		1	0.5 CC (SINGLE APPLICATION SIZE)	
71205		SEALANT		1	2 CC (SINGLE APPLICATION SIZE)	
71206		SILICONE LUBE		1	4 CC (SINGLE APPLICATION SIZE)	
71231		GASKET SEALANT		1	8 MILLILITER SIZE	K-2183
71232		THREAD ADHESIVE		1	10 MILLILITER SIZE	

Group: REMOTE CONTROL

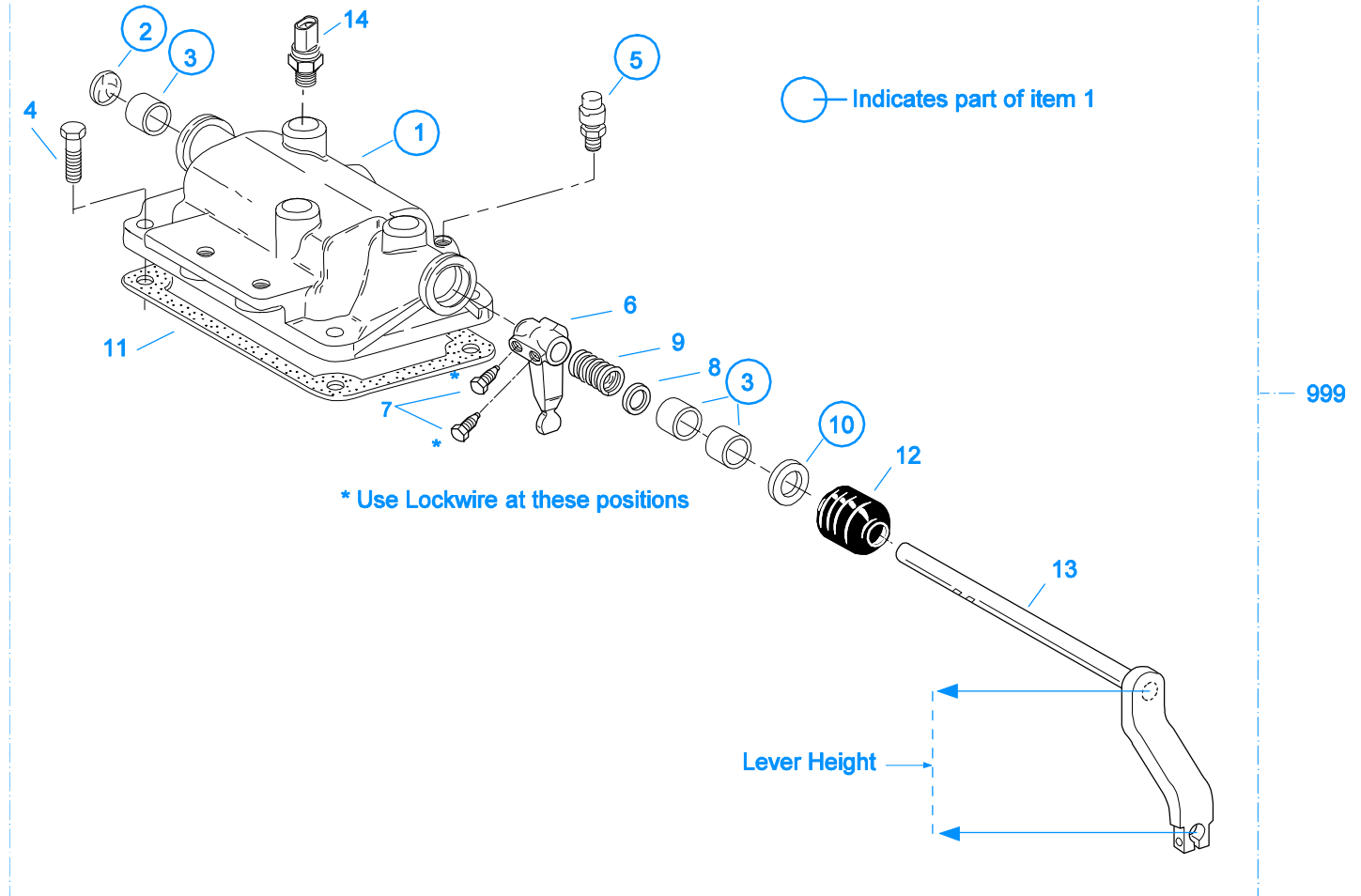

00151-2-94 RCH

REMOTE CONTROL

Item	Current Part	Description	Replaced Part	Qty.	Notes	Kits/Assys Where Needed
1	3316308	CONTROL HOUSING ASSY	22115 3316309	1		
1	A-5537	CONTROL HOUSING ASSY	23263	1	W/NEUTRAL SWITCH OPENING	
1	A-5739	CONTROL HOUSING ASSY	3316309	1	TWO DRILLED AND TAPPED HOLES	A-5741,A-6083
2	12F100	PLUG 1"		1		A-5739
3	3312252	BUSHING		3		A-5537
4	X-8C-604	CAPSCREW		4	3/8"-16X1-1/4"	
5	3315948	BREATHER		1	USE WITH 3316308 HOUSING ASSY	
5	4300217	BREATHER		1		A-5739
6	3316290	SHIFT FINGER		1		A-5741,A-6083
7	3315272	SCREW		2		A-5741,A-6083
8	3312745	WASHER		1		A-6083
9	3315837	SPRING		1		A-6083
10	3312225	OIL SEAL		1		A-5739
11	4301958	GASKET		1		K-7028,K-7061,K-7062,K-7065,K-7069,S-1578,S-1827,S-7045
12	3314302	BOOT		1		A-5741,A-6083
13	A-5273	SHAFT & LEVER ASSY		1	LEVER HEIGHT 3-3/4"	A-5741,A-6083
13	A-5312	SHAFT & LEVER ASSY		1	LEVER HEIGHT 85MM (3.35")	
13	A-5877	NO LONGER AVAILABLE		1	LEVER HEIGHT 5-1/2"	
14	22941	NEUTRAL LIGHT SWITCH	12639	1	SWITCH NORMALLY CLOSED	
999	A-5741	M/R SLAVE CONTROL ASSY		1	LEVER HEIGHT 3-3/4" SPRING AND WASHER NOT INCLUDED	
999	A-5881	NO LONGER AVAILABLE		1	LEVER HEIGHT 5-1/2"	

Item	Current Part	Description	Replaced Part	Qty.	Notes	Kits/Assys Where Needed
999	A-6083	M/R SLAVE CONTROL ASSY		1	LEVER HEIGHT 3-3/4" SPRING AND WASHER INCLUDED	
999	K-7069	REMOTE CONTROL KIT	A - 5403	1	LEVER HEIGHT 85MM (3.35")	

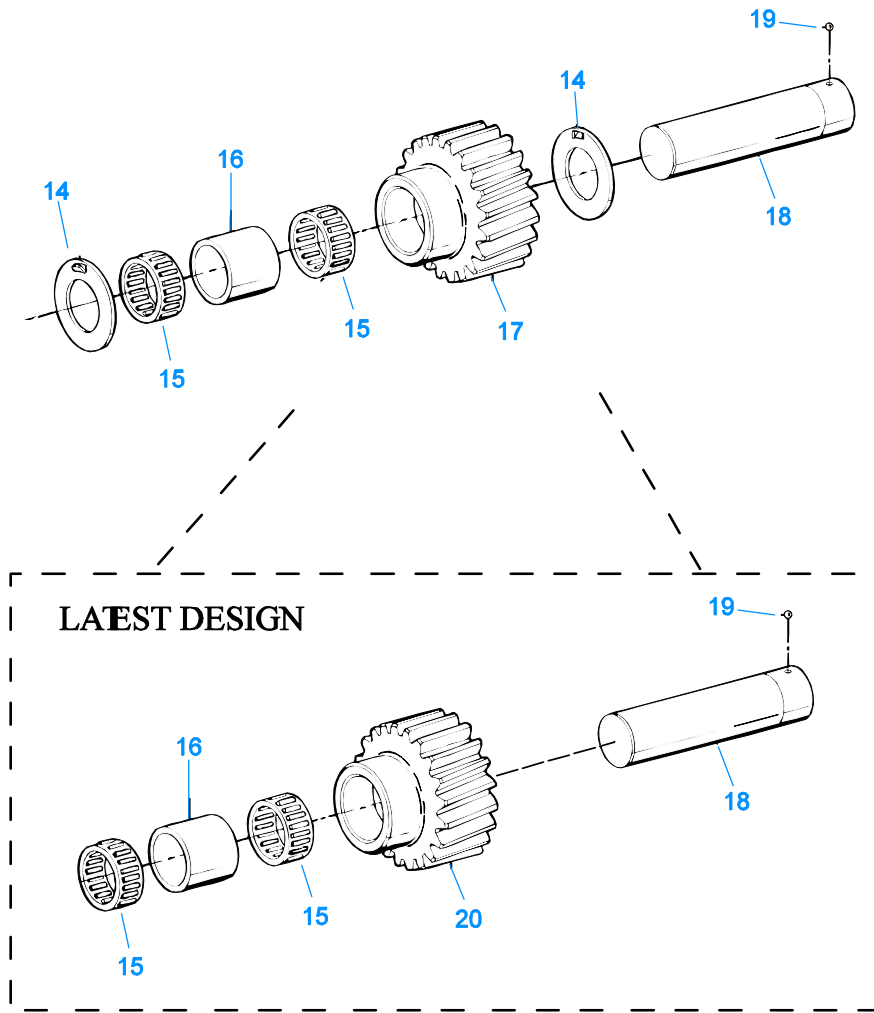

00453-8-93

REVERSE IDLER GEAR ASSY

Item	Current Part	Description	Replaced Part	Qty.	Notes	Kits/Assys Where Needed
14	3315673	WASHER		2		K-3422
15	3315674	BEARING		2		K-3423
16	3315676	SPACER		1		
17	K-3528	REVERSE IDLER GEAR KIT	4301491	1		
18	3315672	REVERSE IDLER SHAFT		1		
19	10J06	STEEL BALL		1	3/16"	K-3422
20	4304318	REVERSE IDLER GEAR		1		K-3528

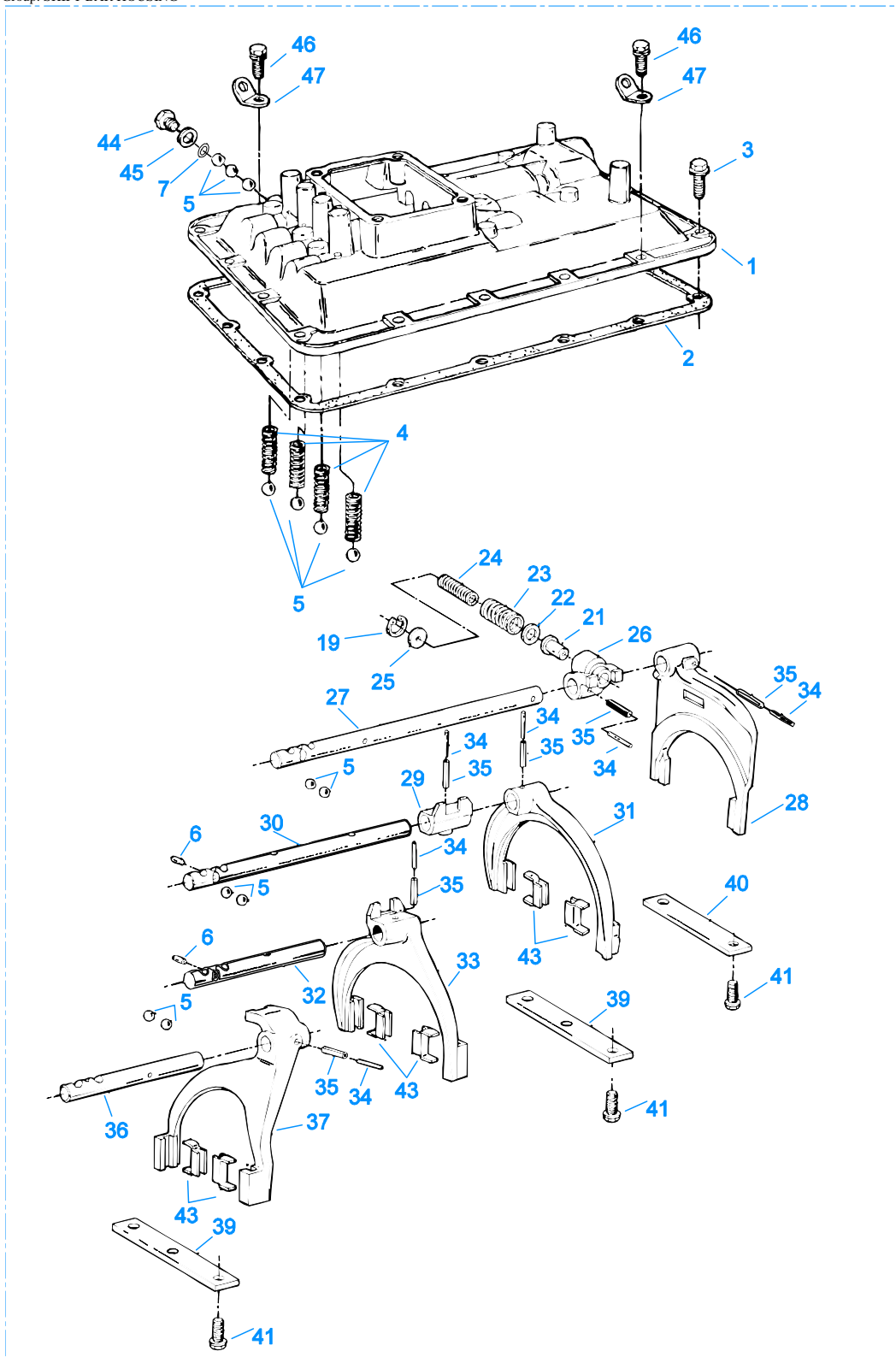

999

00104-8/93 SBH 63

SHIFT BAR HOUSING

Item	Current Part	Description	Replaced Part	Qty.	Notes	Kits/Assys Where Needed
1	A-6744	SHIFT BAR HSG ASSY	3315760 ,4302947	1		

Item	Current Part	Description	Replaced Part	Qty.	Notes	Kits/Assys Where Needed
			,4303606 ,A - 6536 ,A - 6537			
2	4300854	GASKET	3315678	1		K-7028,S-2861
3	X-8C-600	CAPSCREW	239611	14	3/8"-16X1"	
4	3315765	SPRING		4		K-3423
5	10J14	STEEL BALL		13	7/16"	K-3422
6	201044	PIN		2		
7	4301719	BALL RETAINER- REVERSE		1		
19	21736	SNAP RING		1		
21	3316296	PLUNGER		1		
22	3316298	WASHER		1		
23	21723	SPRING		1		
24	21724	SPRING		1		
25	3316295	WASHER		1		
26	3316300	SHIFT BLOCK REV		1		
27	4301469	YOKE BAR REV		1		
28	3315897	YOKE ASSY REV		1		
29	3315778	SHIFT BLOCK 1ST/2ND		1		
30	4304561	YOKE BAR 1ST/2ND	4303819	1		
31	3315772	YOKE ASSY 1ST/2ND	3315770	1		
32	4301471	YOKE BAR 3RD/4TH		1		
33	A-6139	YOKE ASSY 3RD/4TH	4301486	1		
34	1JM6028	PIN		6		
35	1JM3528	PIN		6		
36	4301472	YOKE BAR 5TH/6TH		1		
37	A-6138	YOKE ASSY 5TH/6TH	4301488	1		
39	4301279	SHIFT BAR RETAINER	3315756	2		
40	3315757	SHIFT BAR RETAINER		1		
41	233043	CAPSCREW		8	3/8"-16X1"	
43	227675	INSERT - YOKE PAD		6		A-6138,A-6139,K-3422
44	235052	CA PLUG		1	9/16 - 18	
44	4303656	PLUG	15917	1	9/16 - 18, THREADED	
45	15900	GASKET		1		K-7028,S-2861
46	X-8-688	CAPSCREW		3	3/8"-16X1"	
47	238370	LIFTING EYE		3		
999	S-2861	SHIFT BAR HSG ASSY	4303606	1	COMPLETE REVERSE SWITCH POSITION - RIGHT FRONT	

